

Accessories **Accesorios**

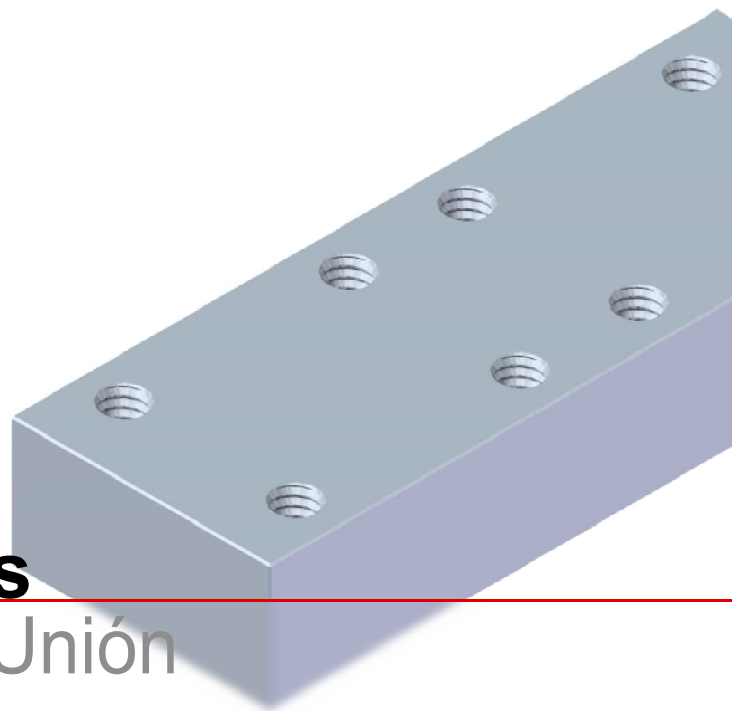

# RideFishplates

Placas de Unión

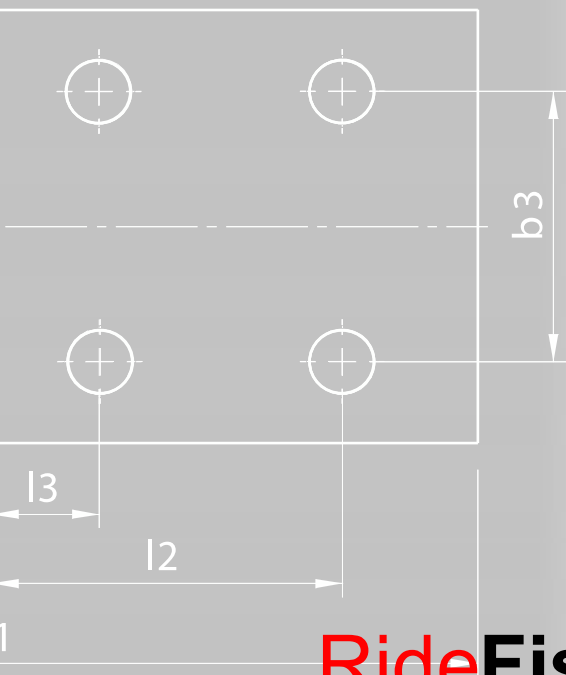

*Elevator System Solutions*

# RideFishplates

## Placas de Unión

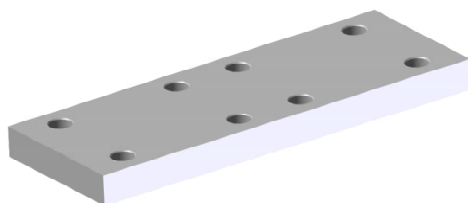

**Estándar**  
Standard

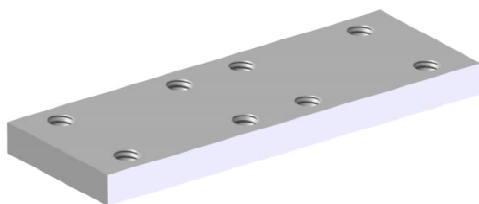

**Roscada**  
Tapped

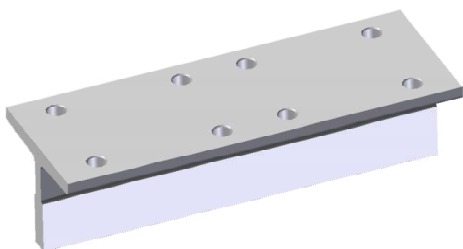

**Placa en T**  
T section

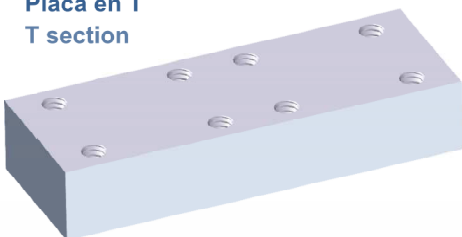

**Placa gruesa roscada**  
Thick, tapped fishplate

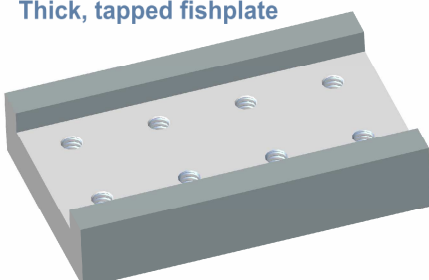

**Placa en U**  
U shape

### Estándar

Disponible en diferentes espesores según tabla y en otros espesores bajo pedido.

### Standard

Available in various thicknesses as shown in the chart below. Other thicknesses available on request.

### Roscada

Para reducir la zona ocupada por el tornillo y la tuerca. Disponible en espesores según tabla y en otros espesores bajo pedido.

### Tapped

To reduce the area occupied by the screw and nut. Available in various thicknesses as shown in the chart below. Other thicknesses available on request.

### Placas con el mismo momento de inercia que la guía STAR

Existen diferentes opciones de placa (En T, Placa gruesa roscada y en forma de U...) con el mismo momento de inercia que la guía.

### Fishplates with the same moment of inertia as the STAR guide rail

There are different options for fishplates (T Section, Thick Fishplates, U shape...) with the same moment of inertia as the guide rail.

**Tabla comparativa de Placas**  
Fishplates Comparison table

	<b>Placa en T</b> T-Section	<b>Placa gruesa</b> Thick FP	<b>Placa en U</b> U-Shape
<b>Peso / Weight</b>	<b>Ligero / Light</b>	<b>Pesado / Heavy</b>	<b>Intermedio / Moderate</b>
<b>Coste / Cost</b>	<b>Bajo / Low</b>	<b>Medio / Medium</b>	<b>Alto / High</b>
<b>Distancia requerida detrás de la guía</b> Space required behind the guide rail	<b>Máximo / Maximun</b>	<b>Medio / Moderate</b>	<b>Mínimo / Minimun</b>

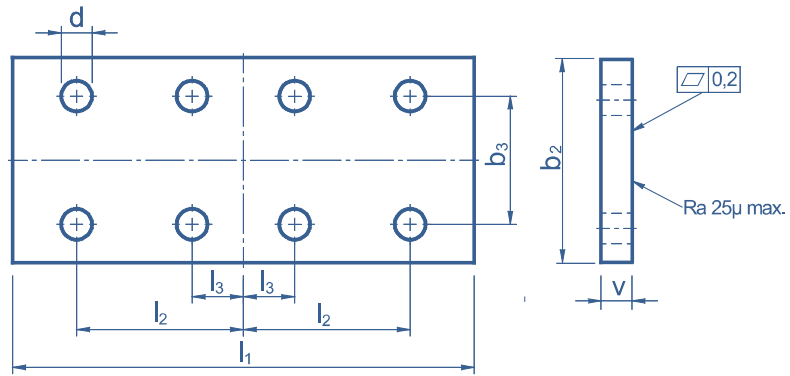

Placas / Fishplates - ISO 7465:2007

Placas Estándar y Roscadas  
Standard and Tapped Fishplates

Distancia entre agujeros, guías y placas (mm)  
Distance between holes, guide rails and fishplates (mm)

		d	b <sub>2</sub>	b <sub>3</sub> ±0,20	l <sub>1</sub> <sup>+3</sup> / <sub>-0</sub>	l <sub>2</sub> ±0,20	l <sub>3</sub> ±0,20	V <sup>+3</sup> / <sub>-0</sub> SUPER	V <sup>+3</sup> / <sub>-0</sub> EXTRA STAR	Roscada Tapped	Tornillo Bolt	Arandela Washer
Calibradas / Cold drawn	T45/A	9	50	25	160	65	15	8	-	M8	M8	A-8
	T50/A	9	50	30	200	75	25	8	-	M8	M8	A-8
	T65/A	10,5	65	40	160	65	15	8	-	M10	M10	A-10
	T70/A	13	70	42	250	105	25	10	-	M12	M12	A-12
	T70-70-9/A	13	70	42	250	105	25	10	-	M12	M12	A-12
	T75/A	13	70	42	250	105	25	10	-	M12	M12	A-12
	T80-80-9/A	13	80	42	250	105	25	10	-	M12	M12	A-12
	T82/A	13	80	50,8	216	81	27	10	-	M12	M12	A-12
	T89/A	13	90	57,2	305	114,3	38,1	13	-	M12	M12	A-12
	T90/A	13	90	57,2	305	114,3	38,1	13	-	M12	M12	A-12
	T125-L1/A	17	130	79,4	305	114,3	38,1	18	-	M16	M16	A-16
	Cepilladas / Machined	T75/B	13	70	42	250	105	25	10	-	M12	M12
T78/B		13	70	42	250	105	25	10	-	M12	M12	A-12
T82/B		13	80	50,8	216	81	27	10	-	M12	M12	A-12
T89/B		13	90	57,2	305	114,3	38,1	13	28	M12	M12	A-12
T90/B		13	90	57,2	305	114,3	38,1	13	28	M12	M12	A-12
T114/B		17	120	70	305	114,3	38,1	18	28	M16	M16	A-16
T125/B		17	130	79,4	305	114,3	38,1	18	28	M16	M16	A-16
T127-1/B		17	130	79,4	305	114,3	38,1	18	28	M16	M16	A-16
T127-2/B		17	130	79,4	305	114,3	38,1	18	28	M16	M16	A-16
T140-1/B		21	140	92,1	380	152,4	31,8	28	38	M20	M20	A-20
T140-2/B		21	140	92,1	380	152,4	31,8	28	38	M20	M20	A-20
T140-3/B		21	140	92,1	380	152,4	31,8	38	48	M20	M20	A-20

Espesores especiales de placas(V)  
Special Thickness of the Fishplates(V)  
Tolerancia <sup>+3</sup>/<sub>-0</sub>  
Tolerance

		13	14	15	19	24	29	34	39	44	49	54	59	74	94	Placa en T T section
Calibradas / Cold drawn	T45/A															
	T50/A															
	T65/A				X											
	T70/A				X											X
	T70-70-9/A		X		X		X			X						X
	T75/A		X		X		X			X						X
	T80-80-9/A															X
	T82/A	X			X		X									X
	T89/A			X	X	X	X		X	X	X					X
	T90/A			X	X	X	X		X	X	X					X
	T125-L1/A															X
	Cepilladas / Machined	T75/B		X		X		X			X					
T78/B			X		X		X			X						X
T82/B		X			X		X									X
T89/B				X	X	X	X		X	X	X					X
T90/B				X	X	X	X		X	X	X					X
T114/B					X											X
T125/B					X	X	X	X		X	X	X				X
T127-1/B					X	X	X	X		X	X	X				X
T127-2/B					X	X	X	X		X	X	X				X
T140-1/B								X	X	X	X	X		X		X
T140-2/B								X	X	X	X	X		X		X
T140-3/B										X	X	X			X	X

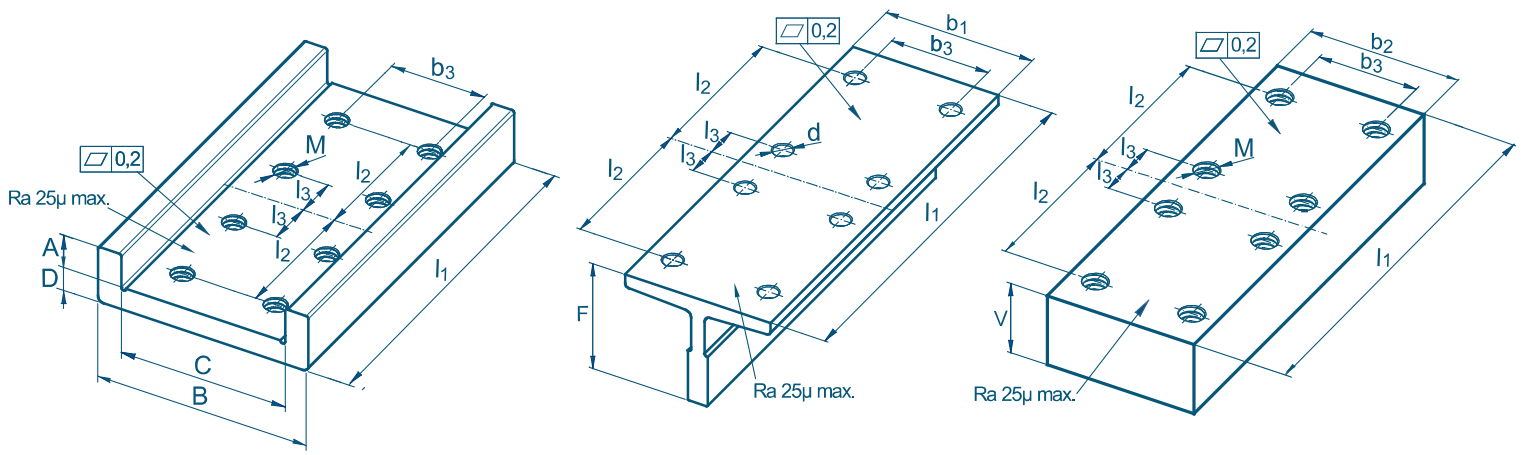

Placas con el mismo momento de inercia que la guía / Fishplates with the same moment of inertia as the guide rail

### Placa en U U shape

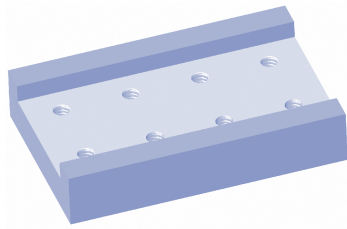

Dimensiones (mm) Dimensions (mm)										
	M	$b_3 \pm 0,2$	$l_1 \begin{smallmatrix} +3 \\ -0 \end{smallmatrix}$	$l_2 \pm 0,2$	$l_3 \pm 0,2$	A	B	C	D	Peso Weight kg/piece
T127-2/B	M16	79,4	305	114,3	38,1	20	200	140	40	21,4
T140-1/B	M20	92,1	380	152,4	31,8	30	215	160	50	36,8
T140-2/B	M20	92,1	380	152,4	31,8	30	215	160	50	36,8
T140-3/B	M20	92,1	380	152,4	31,8	40	215	160	62	46,2

### Placa en T T section

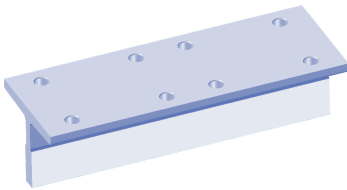

Dimensiones (mm) Dimensions (mm)								
	d	$b_1 \pm 1,5$	$b_3 \pm 0,2$	$l_1 \begin{smallmatrix} +3 \\ -0 \end{smallmatrix}$	$l_2 \pm 0,2$	$l_3 \pm 0,2$	$F \begin{smallmatrix} +3 \\ -0 \end{smallmatrix}$	Peso Weight kg/piece
T127-2/B	17	127	79,4	305	114,3	38,1	88	6,86
T140-1/B	21	140	92,1	380	152,4	31,8	107	10,6
T140-2/B	21	140	92,1	380	152,4	31,8	101	12,96
T140-3/B	21	140	92,1	380	152,4	31,8	126	17,48

### Placa gruesa roscada Thick, tapped fishplate

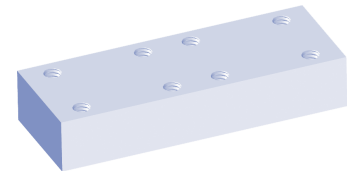

Dimensiones (mm) Dimensions (mm)								
	M	$b_2 \pm 0,2$	$b_3 \pm 0,2$	$l_1 \begin{smallmatrix} +3 \\ -0 \end{smallmatrix}$	$l_2 \pm 0,2$	$l_3 \pm 0,2$	$V \begin{smallmatrix} +3 \\ -0 \end{smallmatrix}$	Peso Weight kg/piece
T127-2/B	M16	130	79,4	305	114,3	38,1	59	17,5
T140-1/B	M20	140	92,1	380	152,4	31,8	74	29,5
T140-2/B	M20	140	92,1	380	152,4	31,8	74	29,5
T140-3/B	M20	140	92,1	380	152,4	31,8	94	38,1

<b>Tipos de Embalaje</b> Types of Packing	<b>Dimensiones</b> Dimensions
<b>Caja de madera con taco</b> Wooden Box with skids	900x600x360 mm 640x440x330 mm 600x300x240 mm
<b>Caja de madera sin taco</b> Wooden Box without skids	340x300x180 mm 430x180x180 mm 290x200x200 mm 290x200x125 mm
<b>Caja de cartón con base de madera</b> Cardboard Box with wooden base	860x540x340 mm 600x400x310 mm 560x260x220 mm
<b>Caja de cartón</b> Cardboard Box	310x260x150 mm 400x150x150 mm 260x170x170 mm 260x175x195 mm

### Suministro de Tornillos

Supply of Screws

	<b>Sets por bolsa</b> Sets per bag
M8	8
M12	8
M16	8
M20	8

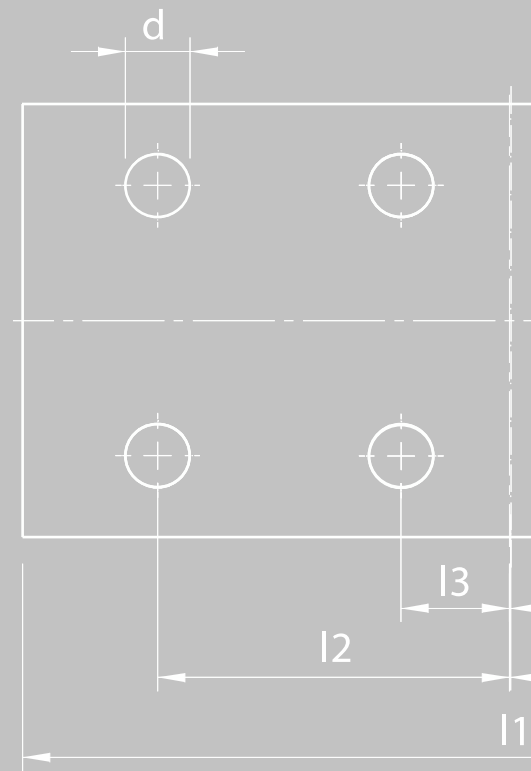

# RideFishplates

## Placas de Unión

Fecha: 04.01.16  
Preparado: J.Sanz  
Revisado : JE.Fernández  
Aprobado : JV.Espín

Bº de Zalain 31780 Bera - Navarra - Spain  
Tel. +34 948 626 900 - Fax +34 948 626 904  
savera@saveragroup.com



*Elevator System Solutions*